

MICROMETER STAND

- Suitable for outside micrometers up to 100mm

Code
6300

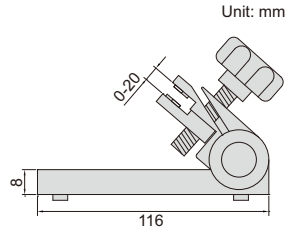

6300



MICROMETER SETTING STANDARDS

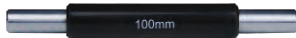

6310-100



type A



6310-300

Unit: mm

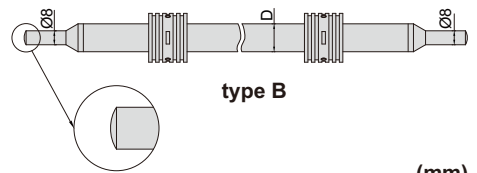

type B

(mm)

Code	Length	Type	Accuracy	D
6310-25	25	A	±1.5µm	Ø7
6310-50	50	A	±2µm	Ø7
6310-75	75	A	±2.5µm	Ø7
6310-100	100	A	±3µm	Ø8
6310-125	125	A	±3.5µm	Ø8
6310-150	150	A	±4µm	Ø8
6310-175	175	A	±4.5µm	Ø8
6310-200	200	A	±5µm	Ø8
6310-225	225	A	±5.5µm	Ø8
6310-250	250	A	±6µm	Ø8
6310-275	275	A	±6.5µm	Ø8
6310-300	300	B	±7µm	Ø16
6310-325	325	B	±7.5µm	Ø16
6310-350	350	B	±8µm	Ø16
6310-375	375	B	±8.5µm	Ø16

Code	Length	Type	Accuracy	D
6310-400	400	B	±9µm	Ø16
6310-425	425	B	±9.5µm	Ø16
6310-450	450	B	±10µm	Ø16
6310-475	475	B	±10.5µm	Ø16
6310-500	500	B	±11µm	Ø16
6310-525	525	B	±11.5µm	Ø16
6310-575	575	B	±12.5µm	Ø16
6310-625	625	B	±13.5µm	Ø16
6310-675	675	B	±14.5µm	Ø16
6310-725	725	B	±15.5µm	Ø16
6310-775	775	B	±16.5µm	Ø16
6310-825	825	B	±17.5µm	Ø16
6310-875	875	B	±18.5µm	Ø16
6310-925	925	B	±19.5µm	Ø16
6310-975	975	B	±20.5µm	Ø16

Code	Length	Type	Accuracy	D
6310-1050	1050	B	±22µm	Ø23
6310-1150	1150	B	±24µm	Ø23
6310-1250	1250	B	±26µm	Ø23
6310-1350	1350	B	±28µm	Ø23
6310-1450	1450	B	±30µm	Ø23
6310-1550	1550	B	±32µm	Ø23
6310-1650	1650	B	±34µm	Ø23
6310-1750	1750	B	±36µm	Ø23
6310-1850	1850	B	±38µm	Ø23
6310-1950	1950	B	±40µm	Ø23

DIGITAL MICROMETER HEADS

- Resolution 0.001mm/0.00005"
- IP65 dust/waterproof
- Button function: on/off, set, mm/inch, ABS/INC
- Data output, automatic power off
- Ratchet stop
- Optional accessory: data output cable (code 7315-30, 7302-30)



6353-25W

IP65
WATERPROOF

DATA
OUTPUT

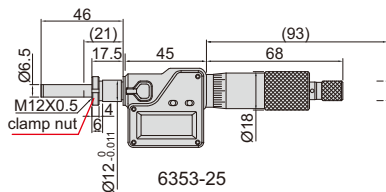

6353-25

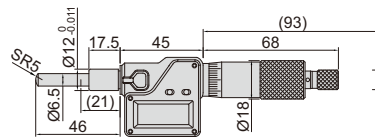

6353-25WS

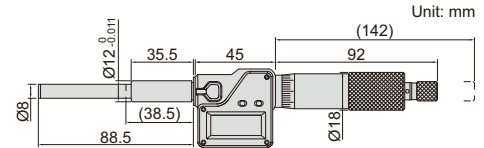

6353-50W

Unit: mm

Rotating spindle

Code	Range	Stem	Spindle tip	Accuracy
6353-25	0-25mm/0-1"	with clamp nut	flat (carbide)	±2µm
6353-25W	0-25mm/0-1"	plain	flat (carbide)	±2µm
6353-25S	0-25mm/0-1"	with clamp nut	spherical (SR5)	±2µm
6353-25WS	0-25mm/0-1"	plain	spherical (SR5)	±2µm
6353-50W	0-50mm/0-2"	plain	flat (carbide)	±4µm

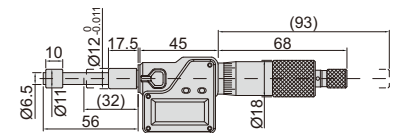

6354-25W

Non-rotating spindle

Code	Range	Stem	Spindle tip	Accuracy
6354-25W	0-25mm/0-1"	plain	flat	±2µm

SMALL MICROMETER HEAD

- Graduation 0.02mm

Code	Range	Stem	Spindle tip	Accuracy
6372-5WS	0-5mm	plain	spherical (SR1.5)	5µm



6372-5WS

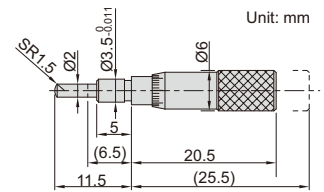

5

SMALL MICROMETER HEADS

- Range 0-6.5mm
- Graduation 0.01mm
- Accuracy 5µm



6385-65W

Code	Stem	Spindle tip
6385-65	with clamp nut	flat
6385-65W	plain	flat
6385-65S	with clamp nut	spherical (SR3)
6385-65WS	plain	spherical (SR3)

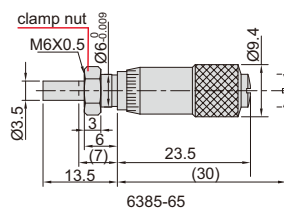

6385-65

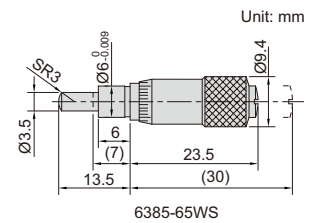

6385-65WS

LARGE THIMBLE MICROMETER HEADS

- Meet DIN863-2
- Large thimble diameter for easy reading
- Graduation 0.01mm
- Accuracy 3µm

Code	Range	Stem	Spindle tip
6373-65	0-6.5mm	with clamp nut	flat
6373-65W	0-6.5mm	plain	flat
6373-65S	0-6.5mm	with clamp nut	spherical (SR3)
6373-65WS	0-6.5mm	plain	spherical (SR3)
6373-13	0-13mm	with clamp nut	flat
6373-13W	0-13mm	plain	flat

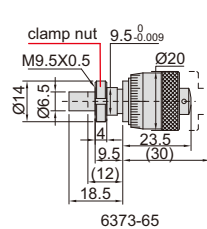

6373-65

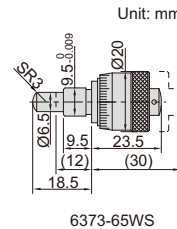

6373-65WS



6373-65

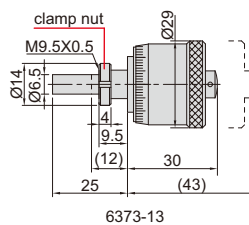

6373-13

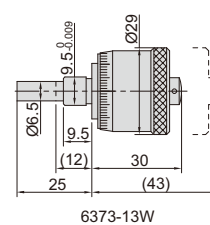

6373-13W



6373-13

MICROMETER HEADS WITH ZERO ADJUSTABLE THIMBLE

- Meet DIN863-2
- Range 0-13mm
- Graduation 0.01mm
- Accuracy 3µm
- The thimble can be set to zero at any position

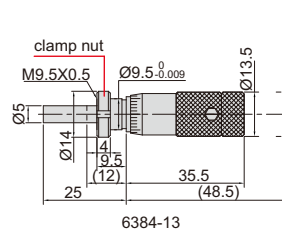

6384-13

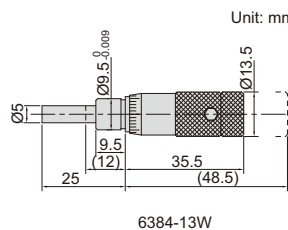

6384-13W



6384-13W

Code	Stem	Spindle tip
6384-13	with clamp nut	flat
6384-13W	plain	flat

MICROMETER HEADS

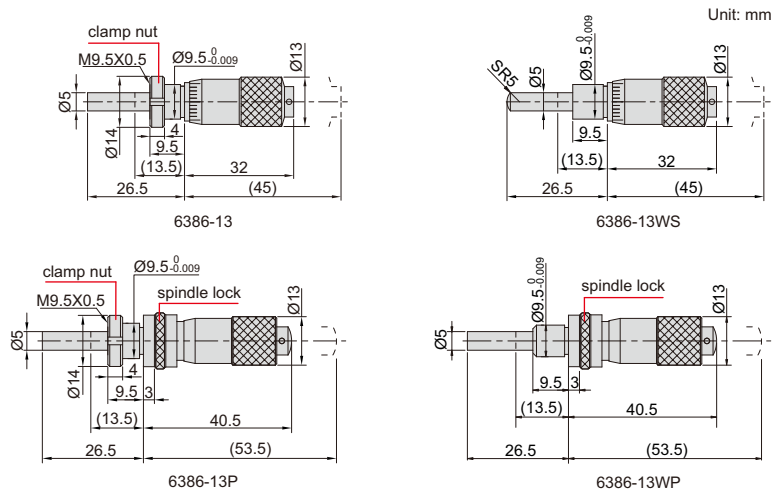

6386-13W



6386-13P

Code	Range	Stem	Spindle tip	Remark	Accuracy
6386-13	0-13mm	with clamp nut	flat		3µm
6386-13W	0-13mm	plain	flat		3µm
6386-13S	0-13mm	with clamp nut	spherical (SR5)		3µm
6386-13WS	0-13mm	plain	spherical (SR5)		3µm
6386-13P	0-13mm	with clamp nut	flat	with spindle lock	3µm
6386-13WP	0-13mm	plain	flat	with spindle lock	3µm

- Meet DIN863-2
- Graduation 0.01mm

MICROMETER HEADS

- Meet DIN863-2
- Graduation 0.01mm
- Accuracy 3µm



6387-15WS

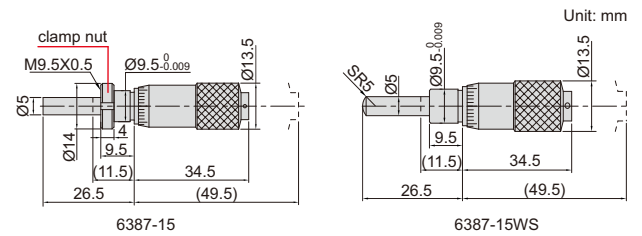

Code	Range	Stem	Spindle tip
6387-15	0-15mm	with clamp nut	flat
6387-15W	0-15mm	plain	flat
6387-15S	0-15mm	with clamp nut	spherical (SR5)
6387-15WS	0-15mm	plain	spherical (SR5)

MICROMETER HEADS

- Meet DIN863-2
- Graduation 0.01mm
- Ratchet stop



6381-25

6381-25P

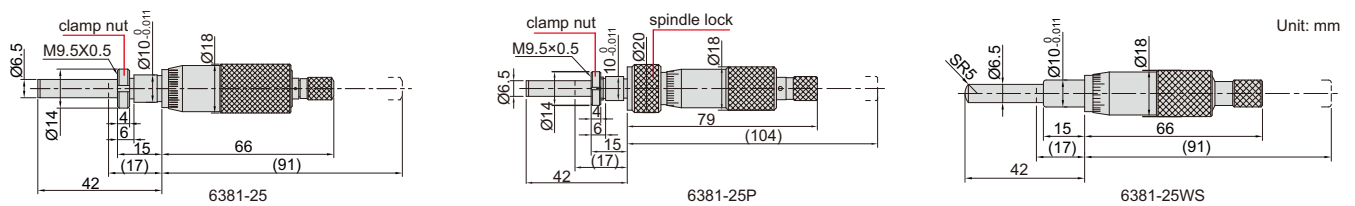

Code	Range	Stem	Spindle tip	Remark	Accuracy
6381-25	0-25mm	with clamp nut	flat (carbide)		3µm
6381-25W	0-25mm	plain	flat (carbide)		3µm
6381-25S	0-25mm	with clamp nut	spherical (SR5)		3µm
6381-25WS	0-25mm	plain	spherical (SR5)		3µm
6381-25P	0-25mm	with clamp nut	flat (carbide)	with spindle lock	3µm
6381-25WP	0-25mm	plain	flat (carbide)	with spindle lock	3µm

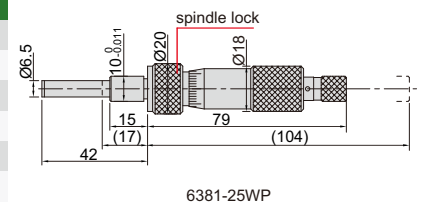

6381-25WP

NON-ROTATING SPINDLE MICROMETER HEAD

- Meet DIN863-2
- Graduation 0.01mm
- Ratchet stop
- Non-rotating spindle



6377-25W

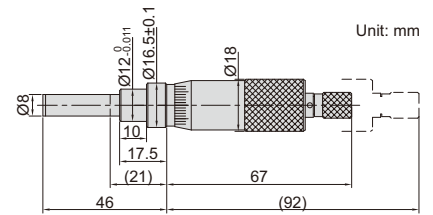

Unit: mm

5

Code	Range	Stem	Spindle tip	Accuracy
6377-25W	0-25mm	plain	flat (carbide)	3µm

LARGE MICROMETER HEADS



6388-50AW

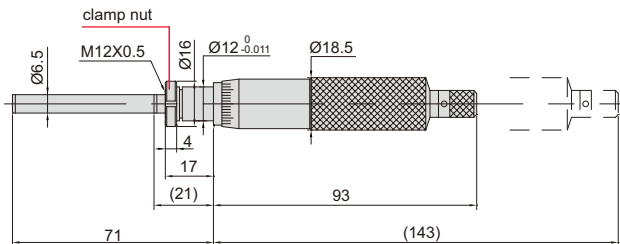

6388-50A

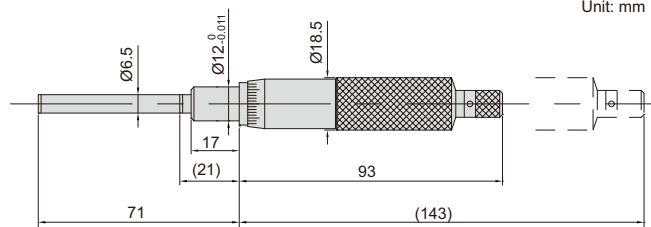

6388-50AW

Unit: mm

Code	Range	Stem	Spindle tip	Accuracy
6388-50A	0-50mm	with clamp nut	flat (carbide)	5µm
6388-50AW	0-50mm	plain	flat (carbide)	5µm

- Graduation 0.01mm
- Ratchet stop

QUICK SPINDLE FEEDING MICROMETER HEADS



6375-15W



6375-25W

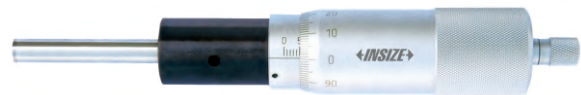

6375-50W

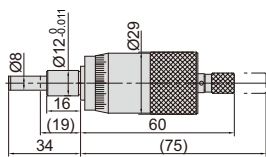

6375-15W

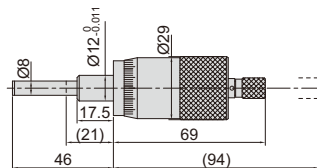

6375-25W

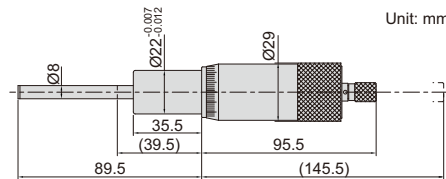

6375-50W

Unit: mm

Code	Range	Stem	Spindle tip	Accuracy
6375-15W	0-15mm	plain	flat (carbide)	3µm
6375-25W	0-25mm	plain	flat (carbide)	3µm
6375-50W	0-50mm	plain	flat (carbide)	5µm

- Micrometers up to 25mm meet DIN863-2
- Graduation 0.01mm
- Quick spindle feed of 1mm/rev.
- Ratchet stop